

# TEH 20 T / TEH 30 T

EN

ORIGINAL INSTRUCTIONS  
ELECTRIC HEATER



**Table of contents**

Notes regarding the instructions ..... 2

Safety ..... 2

Information about the device ..... 4

Transport and storage ..... 5

Assembly and installation ..... 6

Operation ..... 6

Errors and faults ..... 7

Maintenance ..... 9

Technical annex ..... 10

Disposal ..... 13

Declaration of conformity ..... 13

**Notes regarding the instructions**

**Symbols**

 **Warning of electrical voltage**  
 This symbol indicates dangers to the life and health of persons due to electrical voltage.

 **Warning of hot surface**  
 This symbol indicates dangers to the life and health of persons due to hot surface.

 **Warning**  
 This signal word indicates a hazard with an average risk level which, if not avoided, can result in serious injury or death.

 **Caution**  
 This signal word indicates a hazard with a low risk level which, if not avoided, can result in minor or moderate injury.

**Note**  
 This signal word indicates important information (e.g. material damage), but does not indicate hazards.

 **Info**  
 Information marked with this symbol helps you to carry out your tasks quickly and safely.

 **Follow the manual**  
 Information marked with this symbol indicates that the instructions must be observed.

You can download the current version of the instructions via the following link:

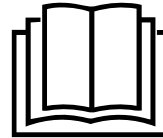

TEH 20 T



<https://hub.trotec.com/?id=44018>

TEH 30 T



<https://hub.trotec.com/?id=44019>

**Safety**

**Read this manual carefully before starting or using the device. Always store the manual in the immediate vicinity of the device or its site of use.**

 **Warning**  
**Read all safety warnings and all instructions.** Failure to follow the warnings and instructions may result in electric shock, fire and/or serious injury. **Save all warnings and instructions for future reference.**  
 This appliance can be used by children aged from 8 years and above and persons with reduced physical, sensory or mental capabilities or lack of experience and knowledge if they have been given supervision or instruction concerning use of the appliance in a safe way and understand the hazards involved. Children shall not play with the appliance. Cleaning and user maintenance shall not be made by children without supervision.

 **Warning**  
 Children of less than 3 years should be kept away from the device unless continuously supervised. Children aged from 3 years and less than 8 years shall only switch on/off the appliance provided that it has been placed or installed in its intended normal operating position and they have been given supervision or instruction concerning use of the appliance in a safe way and understand the hazards involved. Children aged from 3 years and less than 8 years shall not plug in, regulate and clean the appliance or perform user maintenance.



### Warning

Do not use the device in small rooms if persons are present who cannot leave the room independently and who are not under constant supervision.

- Do not use the device in potentially explosive rooms or areas and do not install it there.
- Do not use the device in aggressive atmosphere.
- Only put up the device in an upright, stable position on firm ground.
- Let the device dry out after a wet clean. Do not operate it when wet.
- Do not use the device with wet or damp hands.
- Do not expose the device to directly squirting water.
- Never insert any objects or limbs into the device.
- Do not cover the device during operation.
- Do not remove any safety signs, stickers or labels from the device. Keep all safety signs, stickers and labels in legible condition.
- Do not sit on the device.
- This device is not a toy. Keep away from children and animals. Do not leave the device unattended during operation.
- Check accessories and connection parts for possible damage prior to every use of the device. Do not use any defective devices or device parts.
- Ensure that all electric cables outside of the device are protected from damage (e.g. caused by animals). Never use the device if electric cables or the power connection are damaged!
- The mains connection must correspond to the specifications in the Technical annex.
- Insert the mains plug into a properly fused mains socket.
- Observe the device's power input, cable length and intended use when selecting extensions to the power cable. Completely unroll extension cables. Avoid electrical overload.
- Before carrying out maintenance, care or repair work on the device, remove the mains plug from the mains socket. Hold onto the mains plug while doing so.
- Switch the device off and disconnect the power cable from the mains socket when the device is not in use.
- Do not under any circumstances use the device if you detect damages on the mains plug or power cable. If the power cable is damaged, it must be replaced by the manufacturer, its service agent or similarly qualified persons in order to avoid a hazard. Defective power cables pose a serious health risk!
- When positioning the device, observe the minimum distances from walls and other objects as well as the storage and operating conditions specified in the Technical annex.
- Keep a safety distance of at least 1 m between the air inlet and the air outlet of the device and all combustible materials such as textiles, curtains, beds and sofas.
- Make sure that the air inlet and outlet are not obstructed.
- Do not place the device on combustible ground.
- Only use original spare parts, for otherwise safe and functional operation cannot be ensured.
- Allow the device to cool down before transport and/or maintenance work.
- The device must not be used with a programming switch, timer, separate remote control system or similar equipment that switches the device on automatically, as this could cause a fire hazard if the heater is covered or positioned incorrectly.
- Do not use the device if it has been dropped or if it shows visible signs of damage.

### Intended use

Use the device for heating closed rooms or dry outdoor areas whilst adhering to the technical data. Moreover, the device is suited for drying, defrosting and aeration.

Intended use comprises e.g. heating the air in:

- sheds and stables
- greenhouses
- winter construction sites
- in wet rooms in compliance with the local or national regulations for the operation of electrical equipment in wet rooms.

Intended use comprises e.g. defrosting machines or pipelines.

### Foreseeable misuse

- Do not place any objects, e.g. clothing, on the device.
- Do not use this device in the vicinity of fuel, solvents, varnishes or other easily inflammable vapours or in rooms where these substances are stored.
- Do not use the heating device in immediate vicinity of swimming pools, bathtubs and showers.
- Do not use the device for heating in vehicles.
- Do not place the device on wet or flooded ground.
- The device may not be exposed to weather effects (rain, sunlight).
- Any use other than the intended use is regarded as a reasonably foreseeable misuse.
- Do not make any unauthorised modifications, alterations or structural changes to the device.

## Personnel qualifications

People who use this device must:

- be aware of the dangers that occur when working with electric devices in damp areas.
- have read and understood the instructions, especially the Safety chapter.

Maintenance tasks which require the housing to be opened must only be carried out by specialist electrical companies or by Trotec.

## Electrically skilled person

Electrically skilled personnel must be able to read and understand electric circuit diagrams, to put electrical systems into service and to maintain them, to wire control cabinets, to ensure the functionality of electrical components and to identify possible hazards from electrical and electronic systems.

## Instructed person

Instructed persons have been informed of the tasks they were entrusted with as well as of potential hazards resulting from inappropriate behaviour. They are allowed to operate and transport the device and perform simple maintenance activities (cleaning the housing, cleaning the fan).

The device is to be maintained and looked after by instructed personnel.

## Residual risks



### Warning of electrical voltage

Work on the electrical components must only be carried out by an authorised specialist company!



### Warning of electrical voltage

Before any work on the device, remove the mains plug from the mains socket!

Do not touch the mains plug with wet or damp hands. Hold onto the mains plug while pulling the power cable out of the mains socket.



### Warning of electrical voltage

Risk of electric shock!

Risk of an electric shock if the heating device comes into contact with water in bathtubs, showers or swimming pools!

Do not use this heating device in immediate proximity to bathtubs, showers or swimming pools!



### Warning of hot surface

Parts of this appliance can become very hot and cause burns. Particular attention is to be paid when there are children or vulnerable persons present!



### Warning

Dangers can occur at the device when it is used by untrained people in an unprofessional or improper way! Observe the personnel qualifications!



### Warning

The device is not a toy and does not belong in the hands of children.



### Warning

Risk of suffocation!

Do not leave the packaging lying around. Children may use it as a dangerous toy.



### Warning

Improper installation entails a risk of fire.

Do not place the device on combustible ground.

Do not place the device on high-pile carpets.



### Warning

In order to avoid overheating and fire hazards, the device must not be covered!

## Behaviour in the event of an emergency

1. Switch the device off.
2. Disconnect the device from the mains feed-in: Hold onto the mains plug while pulling the power cable out of the mains socket.
3. Do not reconnect a defective device to the mains.

## Overheating protection

The device is provided with a safety thermostat which is activated by overheating of the device (when exceeding the operating temperature).

Investigate the cause of overheating.

If the safety thermostat does not switch in the event of overheating, the overheating protection will be tripped. In that case the device switches off completely. If so, please contact the customer service to have the overheating protection replaced.

## Information about the device

### Device description

The device serves to generate and to distribute warm air, for speeding up drying processes and for defrosting frozen materials. It can be used either in closed rooms or in dry outdoor areas.

The heating element generates warmth. The air surrounding the heating element is heated. The heated air is distributed in the room by the fan. The integrated thermostat is equipped with a 3-stage temperature adjustment which allows to constantly keep the respective temperature level. The device is further equipped with an overheating protection.

The device is suitable for tough requirements and therefore suited for the use on construction sites (heating and construction drying), in greenhouses or other commercial areas, e.g. for drying earthenware. Besides, the device is suited for continuous operation.

## Device depiction

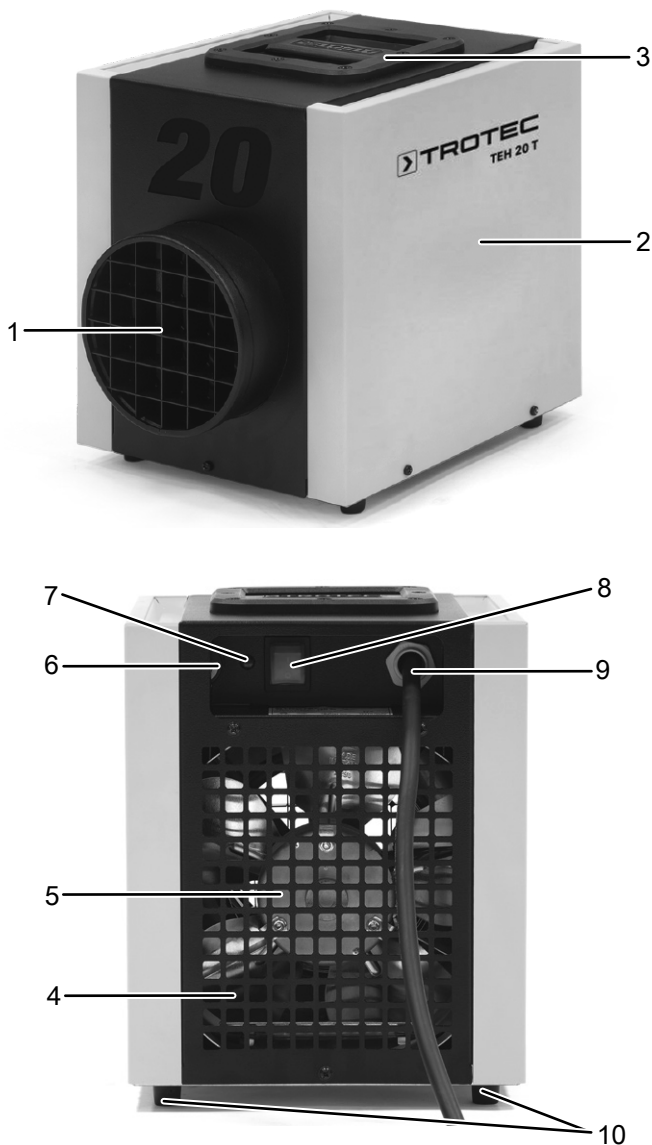

No.	Designation
1	Air outlet
2	Housing
3	Transport handle
4	air inlet
5	Fan
6	Rotary switch <i>temperature</i>
7	Operating control lamp
8	On/off switch
9	Mains connection
10	Feet

## Transport and storage

### Note

If you store or transport the device improperly, the device may be damaged.  
Note the information regarding transport and storage of the device.

### Transport

To make the device easier to transport, it is fitted with a carry handle.

**Before** transporting the device, observe the following:

- Switch the device off.
- Hold onto the mains plug while pulling the power cable out of the mains socket.
- Do not use the power cable to drag the device.
- Allow the device to cool down sufficiently.

### Storage

**Before** storing the device, proceed as follows:

- Hold onto the mains plug while pulling the power cable out of the mains socket.
- Stackable: up to 3 devices may be stacked on top of one another.
- Allow the device to cool down sufficiently.

When the device is not being used, observe the following storage conditions:

- Store the device in a dry location and protected from frost and heat.
- Store the device in an upright position where it is protected from dust and direct sunlight.
- If required, use a cover to protect the device from invasive dust.
- Place no further devices or objects on top of the device to prevent it from being damaged.

## Assembly and installation

### Scope of delivery

- 1 x device
- 1 x Manual

### Start-up



#### Info

Odours might arise upon initial start-up or after a longer period of non-use.

When positioning the device, observe the minimum distance from walls or other objects as described in the chapter Technical annex.

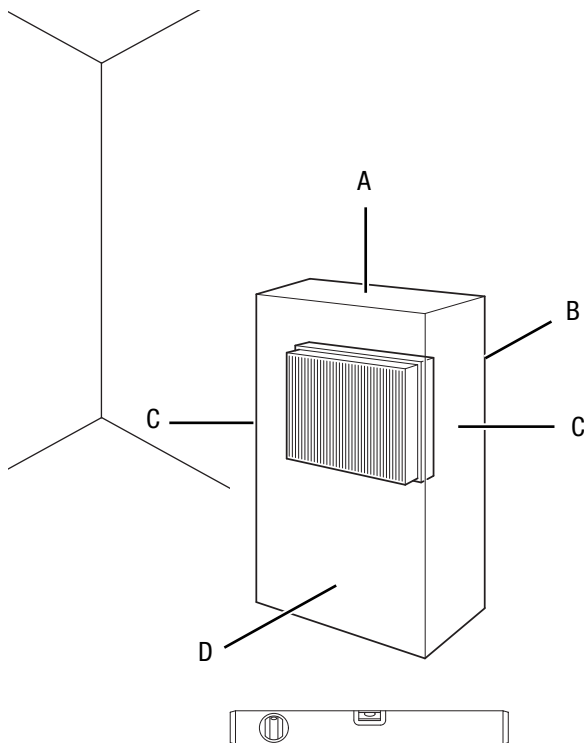

- Before starting the device, check the condition of the power cable. If there are doubts as to their sound condition, contact the customer service.
- The device may only be used in environments with no excessive formation of dust.
- Set the device up in an upright and stable position.
- Do not create tripping hazards when laying the power cable or other electric cables, especially when positioning the device in the middle of the room. Use cable bridges.
- Make sure that extension cables are completely unrolled.
- Make sure that no curtains or other objects interfere with the air flow.
- Make sure that the device cannot come into contact with moisture or water.

### Connecting the power cable

- Insert the mains plug into a properly fused mains socket.
- Make sure that the power cable is guided along the back of the device. Never guide the power cable along the front of the device!

### Operation

#### Note

Avoid open doors and windows.

- Stackable: up to 3 devices may be stacked on top of one another.

### Control panel

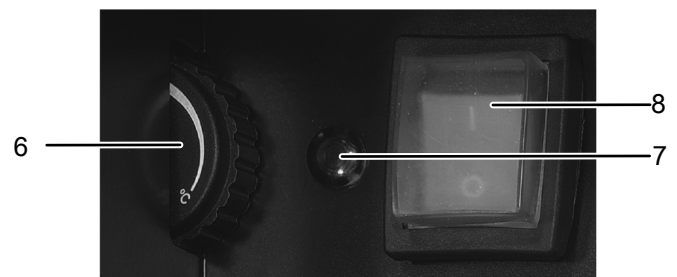

No.	Designation	Meaning
6	Rotary switch <i>temperature</i>	For setting the desired room temperature
7	Operating control lamp	Illuminated during the heating process
8	On/off switch	Switching the device on/off Is illuminated when the device is switched on

### Switching the device on

Once you have completely installed the device as described in the chapter Assembly and start-up, you can switch it on.



#### Info

The device will not be switched on until the room temperature falls below the temperature set at the room thermostat. This holds true for the cold setting as well (ventilation only).

1. Set the on/off switch (8) to I to switch the device on.  
⇒ The on/off switch is illuminated in green and the fan switches on.

## Setting the temperature

1. Select the desired temperature via the stepless rotary switch *temperature* (6) of the room thermostat.

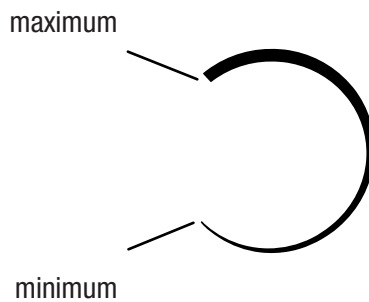

To find the ideal thermostat setting, please proceed as follows:

1. Set the rotary switch *temperature* (6) to the maximum stage.
2. As soon as the desired temperature has been reached, slowly turn the rotary switch *temperature* (6) back until the device is switched off.
  - ⇒ The operating control lamp (7) goes out.
  - ⇒ The device now automatically maintains the desired temperature level.

The room thermostat controls the room temperature automatically:

- When exceeding the set value, both the heating and the ventilation will be switched off.
- When falling below the set value, both the heating and the ventilation will automatically be switched back on.

During the heating process, the operating control lamp (7) is illuminated in red.



### Info

The desired room temperature should be higher than the current room temperature.

## Switching the device off

Please proceed as follows to switch the device off:

1. Turn the rotary switch *temperature* (6) to the cold setting where ventilation mode only is activated.
2. Keep the fan running until the device has cooled down.
  - ⇒ **Never pull the mains plug from the socket while the fan is running. The device may overheat.**
3. Set the on/off switch (8) to **0** to switch the device off.
  - ⇒ The on/off switch is no longer illuminated.

## Shutdown



### Warning of electrical voltage

Do not touch the mains plug with wet or damp hands.

1. Proceed as described in the *Switch the device off* chapter.
2. Hold onto the mains plug while pulling the power cable out of the mains socket.
3. Clean the device according to the Maintenance chapter.
4. Store the device according to the Storage chapter.

## Errors and faults

The device has been checked for proper functioning several times during production. If malfunctions occur nonetheless, check the device according to the following list.

### The device does not start:

- Check the power connection.
- Check the power cable and mains plug for damage. If you notice damages, do not try to take the device back into operation.

If the supply cord is damaged, it must be replaced by the manufacturer, its service agent or similarly qualified persons in order to avoid a hazard.

- Check the on-site fusing.
- The motor might be defective. Have a defective motor replaced by a specialist electrical company.
- The room thermostat might be defective. Have a defective room thermostat replaced by a specialist electrical company.
- Wait for 10 minutes before restarting the device. If the device is not starting, have the electricians checked by a specialist company or by Trotec.

### The device is switched on, the fan is operating, the heating is not:

- Check the room temperature. The room thermostat may have switched off, because the desired room temperature has been reached.
- Check whether the overheating protection has tripped (see chapter Safety).
- The heating resistor might have blown. Have a defective heating resistor replaced by a specialist electrical company.
- The heating element may be defective. If the heating element is defective, have it replaced by a specialist electrical company.
- The room thermostat might be defective. Have a defective room thermostat replaced by a specialist electrical company.

### The fan is not running:

- Check whether the device is switched on.
- Check the power connection.
- Check the power cable and mains plug for damages.
- The fan motor might be defective. Have a defective fan motor replaced by a specialist electrical company.

**The device is loud or vibrates:**

- Check whether the device is set up in a stable and upright position.
- Check the fan for dirt or damages.
- Have the motor checked by an authorised specialist company or by Trotec. There may be a bearing damage on the motor.
- Check the fan blades for dirt and clean them if required (see chapter Maintenance).
- If the fan blades are defective, have them replaced by a specialist company or by Trotec.

**The device still does not operate correctly after these checks:**

Please contact the customer service. If necessary, bring the device to an authorised specialist electrical company or to Trotec for repair.



## Maintenance

## Maintenance intervals

Maintenance and care interval	before every start-up	as needed	at least every 2 weeks	at least every 4 weeks	at least every 6 months	at least annually
Check air inlets and outlets for dirt and foreign objects and clean if necessary	X					
Check air inlet grid(s) for dirt and foreign objects and clean if necessary	X		X			
Clean the exterior		X				X
Visually check the inside of the device for dirt		X		X		
Check for damage	X					
Check attachment screws		X				X
Test run						X

## Maintenance and care log

Device type: .....

Device number: .....

Maintenance and care interval	1	2	3	4	5	6	7	8	9	10	11	12	13	14	15	16
Check air inlets and outlets for dirt and foreign objects and clean if necessary																
Check air inlet grid(s) for dirt and foreign objects and clean if necessary																
Clean the exterior																
Visually check the inside of the device for dirt																
Check for damage																
Check attachment screws																
Test run																
Comments																

1. Date: .....	2. Date: .....	3. Date: .....	4. Date: .....
Signature: .....	Signature: .....	Signature: .....	Signature: .....
5. Date: .....	6. Date: .....	7. Date: .....	8. Date: .....
Signature: .....	Signature: .....	Signature: .....	Signature: .....
9. Date: .....	10. Date: .....	11. Date: .....	12. Date: .....
Signature: .....	Signature: .....	Signature: .....	Signature: .....
13. Date: .....	14. Date: .....	15. Date: .....	16. Date: .....
Signature: .....	Signature: .....	Signature: .....	Signature: .....

**Activities required before starting maintenance**



**Warning of electrical voltage**

Do not touch the mains plug with wet or damp hands.

- Switch the device off.
- Hold onto the mains plug while pulling the power cable out of the mains socket.
- Allow the device to cool down completely.



**Warning of electrical voltage**

**Tasks which require the device to be opened must only be carried out by authorised specialist companies or by Trotec.**

**Cleaning the housing**



**Warning of electrical voltage**

Never immerse the device in water!

Clean the housing with a soft, damp and lint-free cloth. Make sure that no moisture enters the housing. Protect electrical components from moisture. Do not use any aggressive cleaning agents such as cleaning sprays, solvents, alcohol-based or abrasive cleaners to dampen the cloth.

Wipe the housing dry after cleaning.

**Visual inspection of the inside of the device for dirt**

1. Use a torch to illuminate the openings of the device.
2. Check the inside of the device for dirt.
3. If you see a thick layer of dust, have the inside of the device cleaned by a specialist electrical company or by Trotec.

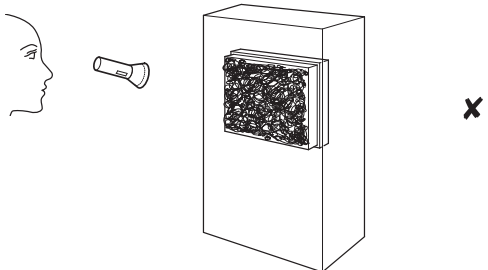
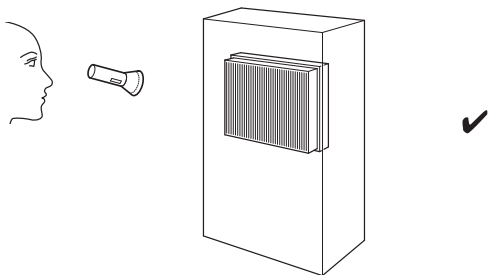

**Technical annex**

**Technical data**

Parameter	Value	
Model	TEH 20 T	TEH 30 T
Heating capacity	2.5 kW	3.3 kW
Amount of air nominal:	300 m <sup>3</sup> /h	300 m <sup>3</sup> /h
effective:	130 m <sup>3</sup> /h	130 m <sup>3</sup> /h
Temperature increase ΔT	57 °C	75 °C
Mains connection	220 – 240V ~ 50 Hz	220 – 240V ~ 50 Hz
Nominal current consumption	11.4 A	15 A
Type of protection	IP14	IP14
Sound pressure level (distance of 1 m)	62 dB(A)	63 dB(A)
Dimensions (length x width x height)	325 x 260 x 332 mm	325 x 260 x 332 mm
Minimum distance to walls and other objects	top (A): 50 cm rear (B): 50 cm sides (C): 50 cm front (D): 50 cm	50 cm 50 cm 50 cm 50 cm
Weight	10.5 kg	10.5 kg

Circuit diagram TEH 20 T / TEH 30 T

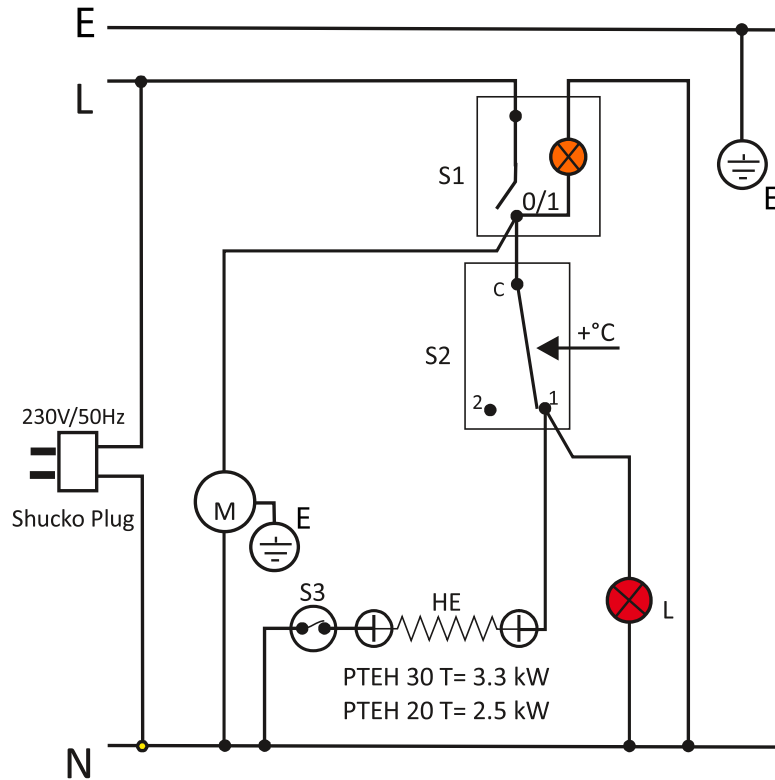

- E - Earthing
- L - Electric Phase
- N - Common Line
- S1 - On-Off switch
- S2 - Room Thermostat
- S3 - Safety Thermostat
- M - Fan motor
- HE - Heating Element
- L - Red lamp (Heating Element ON)

**Overview TEH 20 T / TEH 30 T**



**Info**

The position numbers of the spare parts differ from those describing the positions of the components mentioned in these instructions.

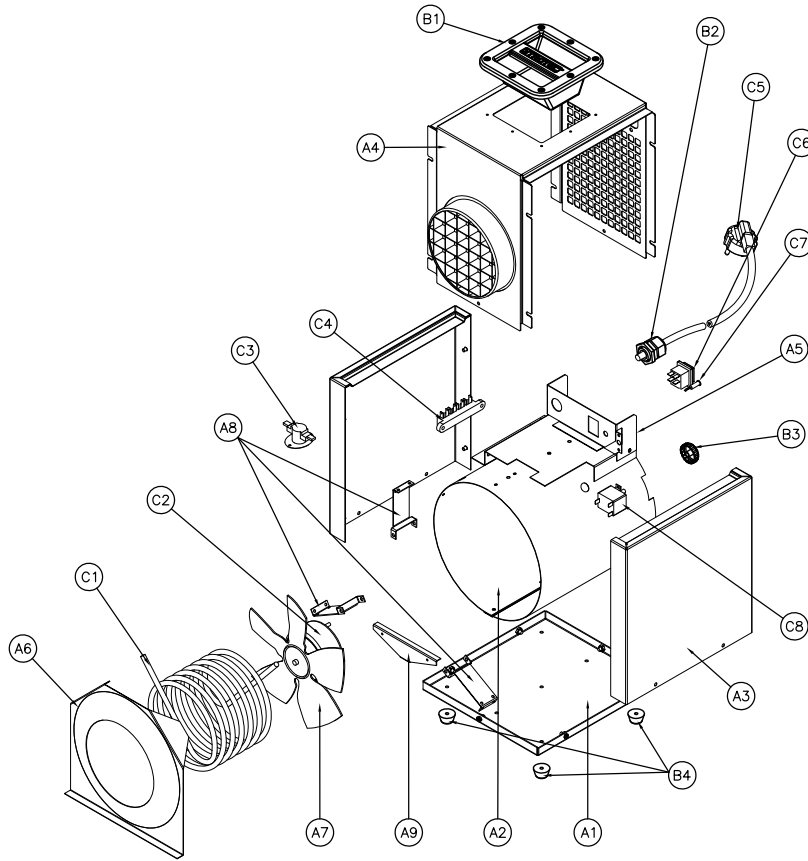

**List of spare parts TEH 20 T / TEH 30 T**

No.	Spare part	No.	Spare part
A1	Baseplate	B3	Room thermostat knob
A2	Air flow duct	B4	Rubber feet
A3	Yellow (RAL1021) painted side panel	C1	3.3kW Heating element (TEH30T) 2.5kW Heating element (TEH20T)
A4	Black painted hood (Ø150mm Hose connection)	C2	Motor fan
A5	Black painted command baseplate + Control panel	C3	60°C Bimetallic thermostat - 20A
A6	Room thermostat support	C4	Terminal block
A7	Air outlet protection shield	C5	Supply cable with Schuko plug
A8	Ø230 Aluminium fan blade	C6	I/O Switch (Green Fluor)
A9	Motor fan brackets	C7	Heating element lamp (Red)
A10	Bulb thermostat protection	C8	TY95 Room thermostat
B1	ABS Grip + Back cover		
B2	Cable gland PG16		

## Disposal

Always dispose of packing materials in an environmentally friendly manner and in accordance with the applicable local disposal regulations.



The icon with the crossed-out waste bin on waste electrical or electronic equipment stipulates that this equipment must not be disposed of with the household waste at the end of its life. You will find collection points for free return of waste electrical and electronic equipment in your vicinity. The addresses can be obtained from your municipality or local administration. You can also find out about other return options that apply for many EU countries on the website <https://hub.trotec.com/?id=45090>. Otherwise, please contact an official recycling centre for electronic and electrical equipment authorised for your country.

The separate collection of waste electrical and electronic equipment aims to enable the re-use, recycling and other forms of recovery of waste equipment as well as to prevent negative effects for the environment and human health caused by the disposal of hazardous substances potentially contained in the equipment.

### Only for United Kingdom

According to Waste Electrical and Electronic Equipment Regulations 2013 (SI 2013/3113) (as amended) devices that are no longer usable must be collected separately and disposed of in an environmentally friendly manner.

## Declaration of conformity

Declaration of conformity in accordance with the EC Machinery Directive 2006/42/EC, Annex II, Part 1, Section A

We – Trotec GmbH – declare in sole responsibility that the product designated below was developed, constructed and produced in compliance with the requirements of the EC Machinery Directive in the version 2006/42/EC.

**Product model / Product:** TEH 20 T  
TEH 30 T

**Product type:** electric heater

**Year of manufacture as of:** 2022

### Relevant EU directives:

- 2011/65/EU
- 2012/19/EU
- 2014/30/EU
- 2015/863/EU

### Applied harmonised standards:

- EN 55014-1:2017/A11:2020

### Applied national standards and technical specifications:

- EN IEC 61000-3-2:2019
- EN 55014-2:2015
- EN 60335-1:2012/A1:2019
- EN 60335-1:2012/A2:2019
- EN 60335-1:2012/A14:2019
- EN 60335-2-30:2009/A11:2012
- EN 60335-2-30:2009/A1:2020
- EN 60335-2-30:2009/A12:2020
- EN 61000-3-3:2013/A1:2019

### Manufacturer and name of the authorised representative of the technical documentation:

Trotec GmbH  
Grebbeener Straße 7, D-52525 Heinsberg  
Phone: +49 2452 962-400  
E-mail: [info@trotec.de](mailto:info@trotec.de)

Place and date of issue:

Heinsberg, 15.08.2022



Joachim Ludwig, Managing Director

Trotec GmbH

Grebener Str. 7  
D-52525 Heinsberg

☎ +49 2452 962-400

☎ +49 2452 962-200

✉ [info@trotec.com](mailto:info@trotec.com)

[www.trotec.com](http://www.trotec.com)